

RETARDER PROOFING

600x400 COUNTERS

Model: TALH/21

Code: 42502021

PLANET

RETARDER PROVER COUNTER WITH HUMIDITY CONTROL - Retarder-prover counter suitable for 600x400 containers/trays with humidity control.

- Construction: made in stainless steel
- Multifunction and multilingual
- Internal capacity: 600x400 mm trays
- Position of technical compartment: on right side
- Refrigeration type: refrigeration system HSS "Helped Static System"
- Control board panel: 5" TOUCH screen control board
- Prearranged to be installed on plinth
- Defrosting system: automatic with heating elements
- Evaporation of condensation water: automatic
- Supply with: 7 pair of runners each door



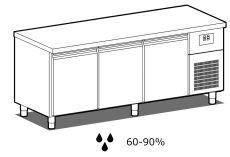

Technical Data:

Body Height	mm	710
Doors	nr	3
Capacity (net)	l	404
Capacity (gross)	l	605
Capacity of trays/shelves	mm	21 600x400
External dimensions (WxDxH)	cm	210 x 80 x 90
Insulation thickness	mm	50
Tray pitch	mm	75
Rack positions	nr	7
Stainless steel top thickness	mm	15/10 H 40
Top type		AISI 304 normal
Evaporators	nr	1
Standard lock		NO
Standard light		NO
Temperature	°C	-2/+35°C
Condensing unit		plug-in unit
Gas		R290
Ventilation control		NO
Humidity control		NO
Relative humidity	ur%	60-90%
Max abs. power	W	1100***
Cooling power	W	650*
Input voltage		1x230V ~ 50Hz
Climate class		5
Packaging dimensions (WxDxH)	cm	225 x 96 x 110
Volume (gross)	mc	2,38
Net weight	kg	208
Gross weight	kg	223

*Evap. -10°C, Cond +45°C / *** Heating

DETAILS:



Humidity control with electronic probe



The stainless steel h 40 mm worktops are reinforced and made with 15/10 sheet metal



Stainless steel cm 40x60 tray



Ecological gas (R290)



Remote monitoring system via GEMM-Cloud Wi-Fi connection (on request)



5" TOUCH electronic board

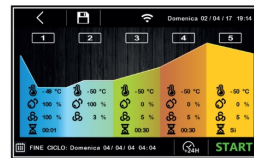

Automatic work cycle



Manual work cycle



Humidity control with electronic probe

ACCESSORIES:



Rilsan cm 60x40 shelf

45020550



Pair of runners for 60x40 cm trays

20808031



Stainless steel cm 40x60x2h tray

42000560

Stainless steel cm 40x60x3h tray

42000562



Set of no. 4 Ø 125 castors

40200530



Set of no. 6 Ø 125 castors

40200532



Wi-Fi supervising system for AFLV, BCT (overprice)

45000563



60Hz frequency

40200560

INSTALLATION DIAGRAM:

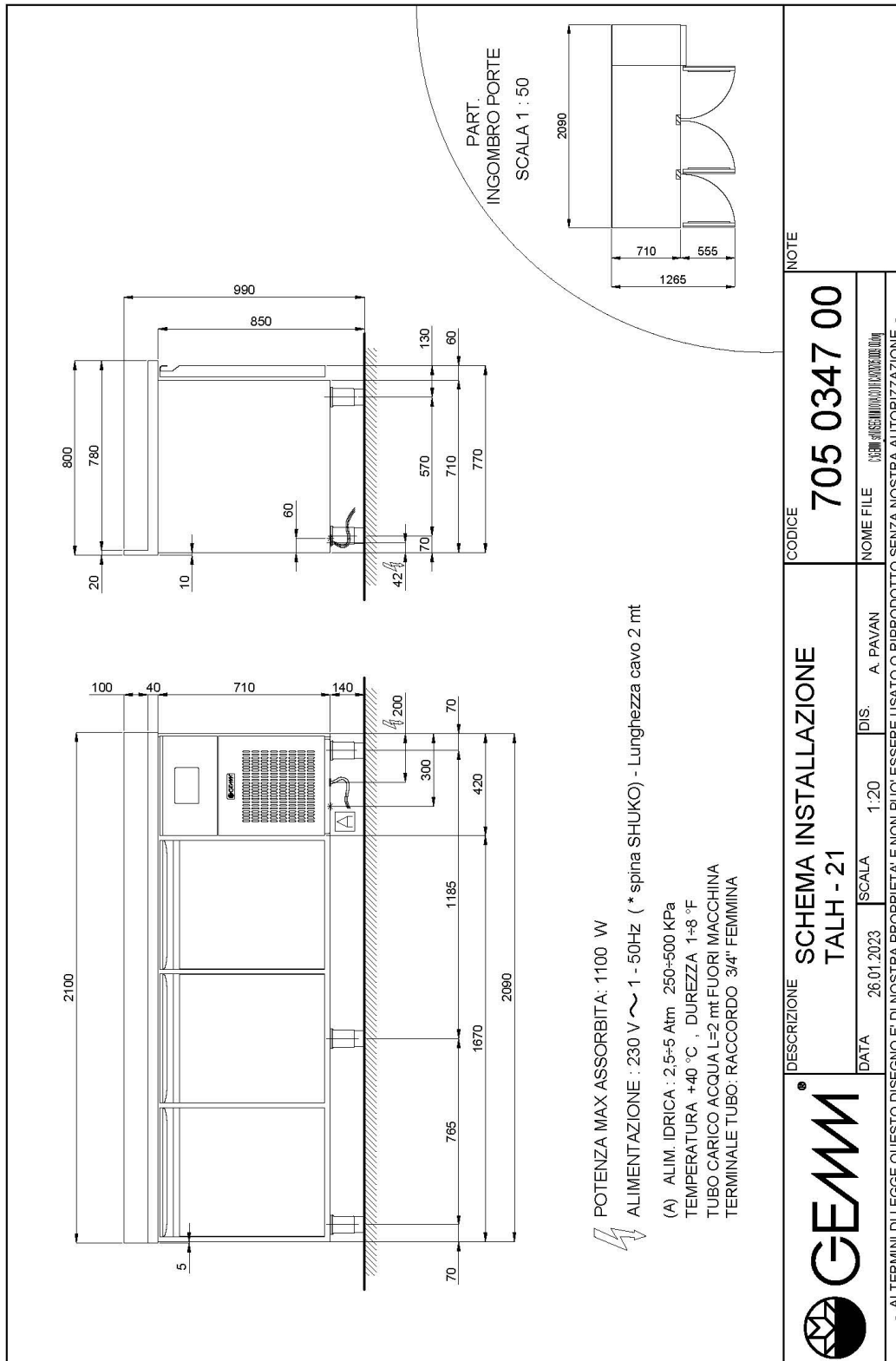

TALH/21